

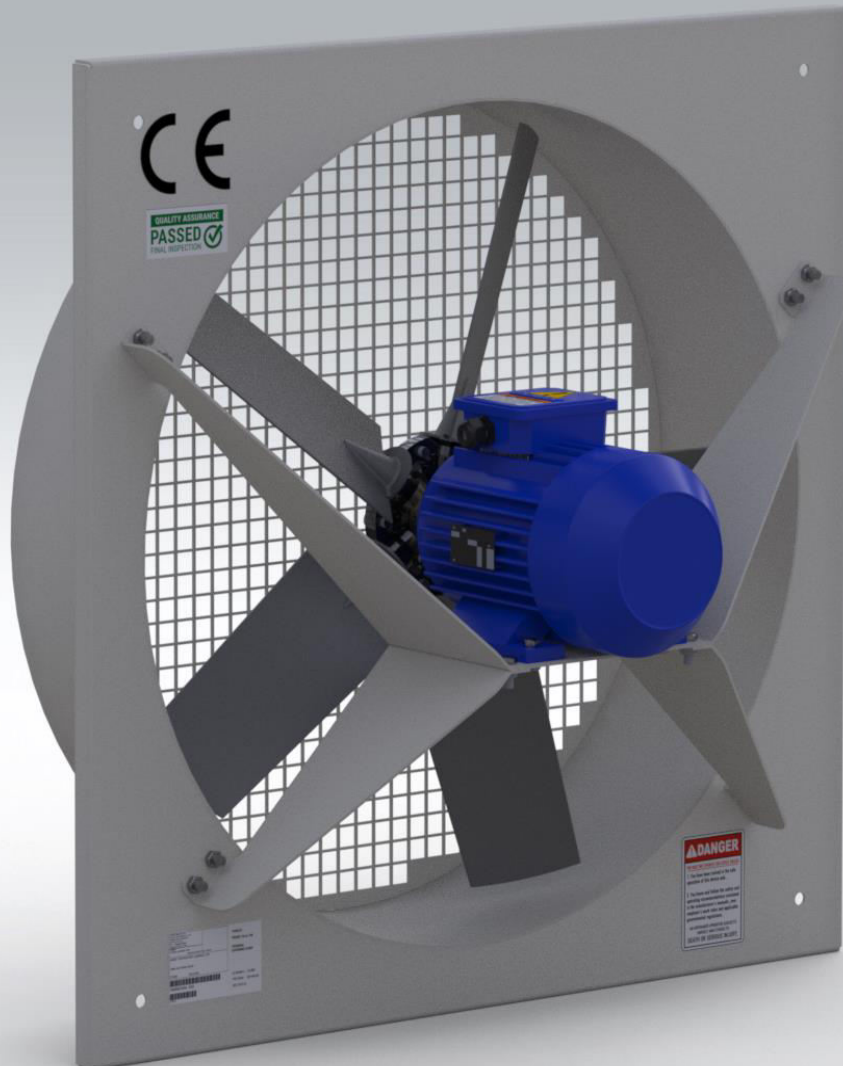

Product Catalogue



D-FWA *Wall Mounted* *Axial Fan*



Technical Specifications

WALL MOUNTED AXIAL FAN

D-FWA series wall mounted axial fans are the ideal fans for wall mounting in ventilation systems where high air flow is required. Thanks to their compact construction, they can be mounted directly on the wall. D-FWA series wall mounted axial fans have high performance, trouble-free operation.

It is manufactured between $\varnothing 500\text{mm}$ and $\varnothing 1000\text{mm}$ diameters. The body is made of high quality, corrosion-resistant galvanized steel. The propellers are made of special aluminum alloy with adjustable blade angles. It is manufactured as standard (380 V - 50 Hz) or other voltages and frequencies. Motors can be single-speed or double speed and have Class H, S1, IP55 insulation.

Optionally, it can be manufactured with Ex-Proof feature.

Usage Areas

It can be used in all kinds of industrial, office, warehouse, hangar, workshop and residential projects to meet the ventilation requirement.

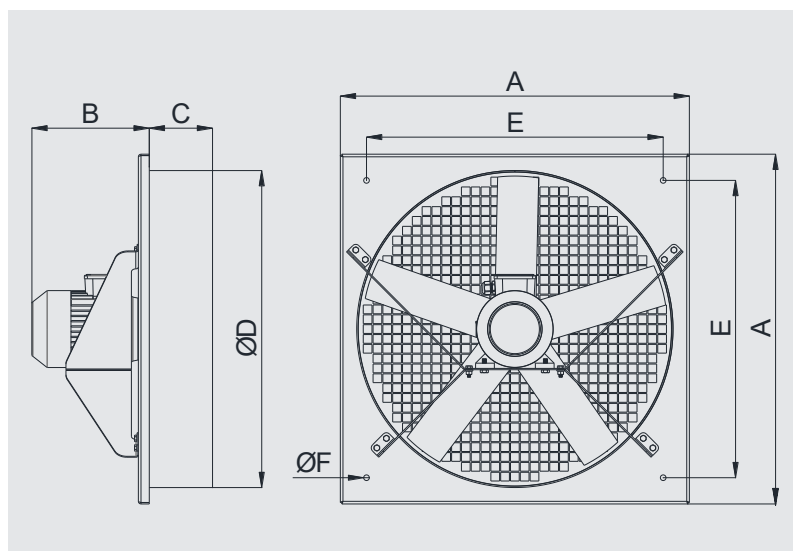
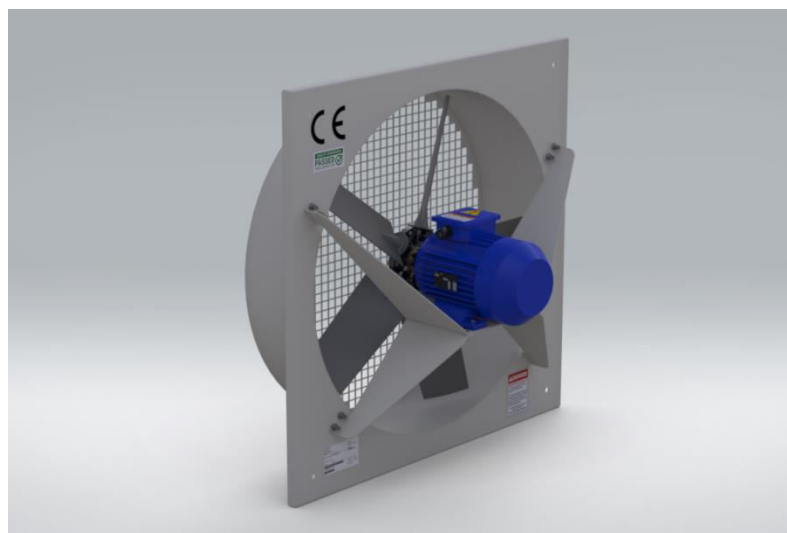

MODEL	A	B	C	D	E	F	MOTOR POWER	CURRENT	NOS. OF POLES	VOLTAGE	FREQUENCY
	mm	mm	mm	mm	mm	mm	kW	A		V	Hz
D-FWA 400	500	212	105	420	380	13	0,18	0,6	4	380	50
D-FWA 450	550	210	105	470	430	13	0,37	1,1	4	380	50
D-FWA 500	600	260	105	520	480	13	0,55	1,6	4	380	50
D-FWA 600	700	260	105	620	580	13	0,75	2,1	4	380	50
D-FWA 700	800	270	145	725	680	13	1,1	2,6	4	380	50
D-FWA 800	950	320	195	825	830	13	2,2	5,1	4	380	50
D-FWA 900	1050	340	220	925	930	15	4	8,2	4	380	50
D-FWA 1000	1150	36	220	1025	1030	15	5,5	11,3	4	380	50

Performance Curves

D-FWA 400

Nos. of Blades 5
 Hub Size 5
 Pitch Angle 35°
 Nos. of Poles 4
 Material Aluminum

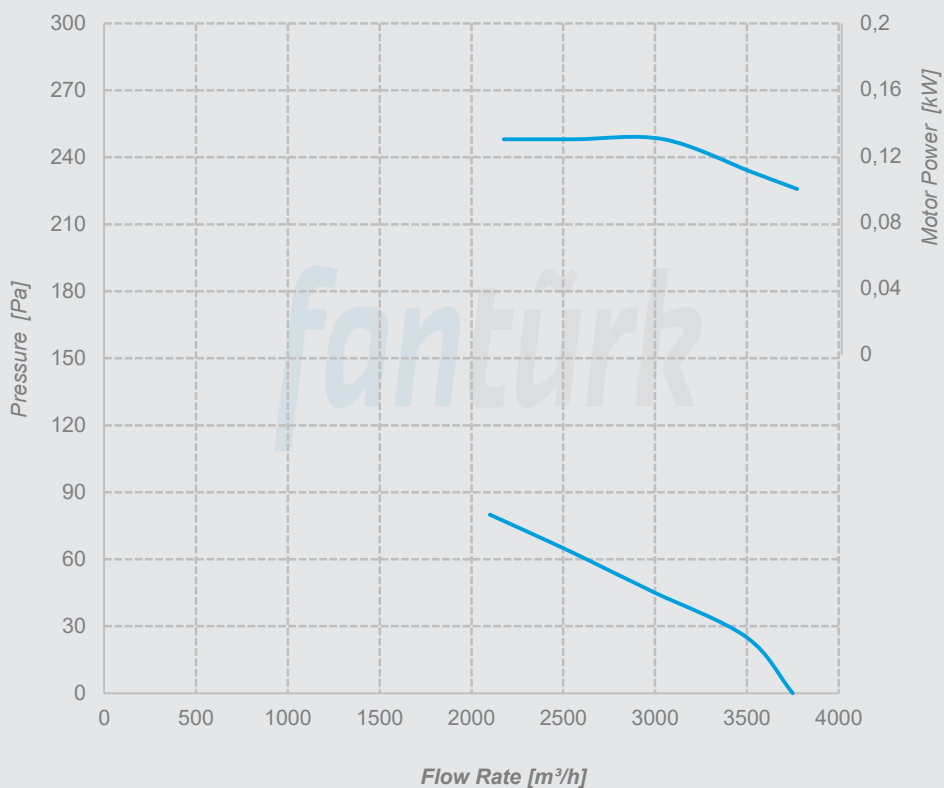

D-FWA 450

Nos. of Blades 5
 Hub Size 5
 Pitch Angle 30°
 Nos. of Poles 4
 Material Aluminum

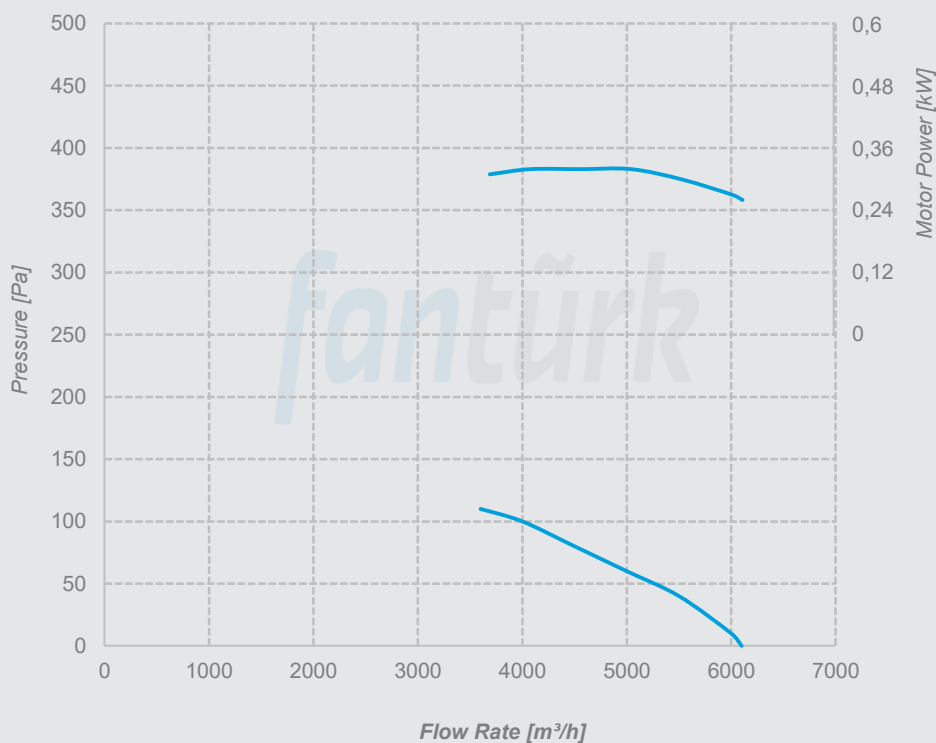

Performance Curves

D-FWA 500

Nos. of Blades 5
 Hub Size 5
 Pitch Angle 35°
 Nos. of Poles 4
 Material Aluminum

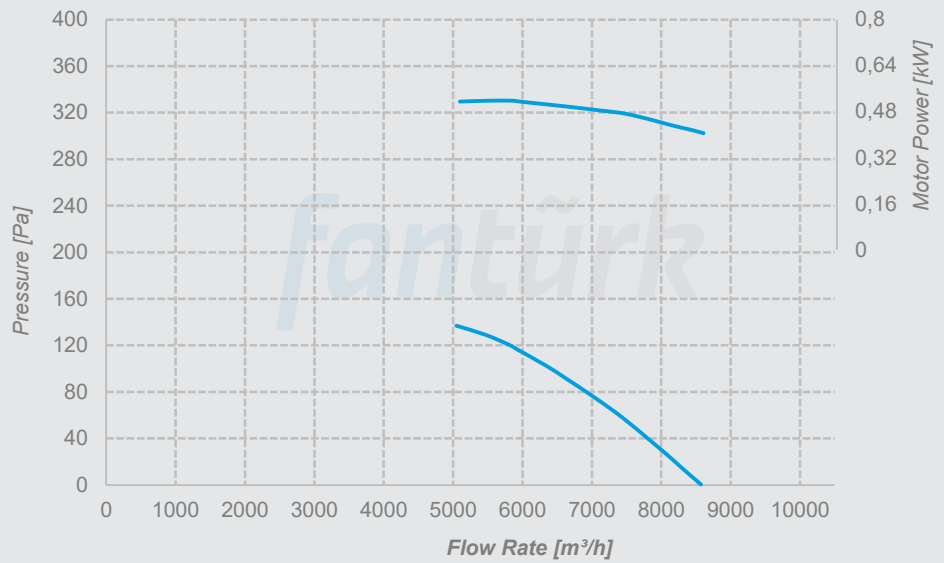

D-FWA 600

Nos. of Blades 5
 Hub Size 5
 Pitch Angle 30°
 Nos. of Poles 4
 Material Aluminum

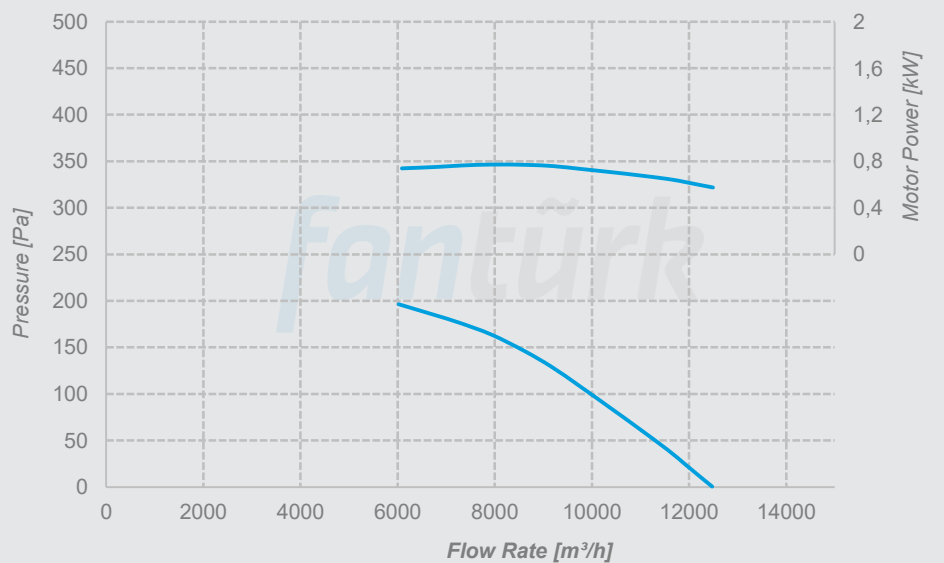

D-FWA 700

Nos. of Blades 5
 Hub Size 5
 Pitch Angle 25°
 Nos. of Poles 4
 Material Aluminum

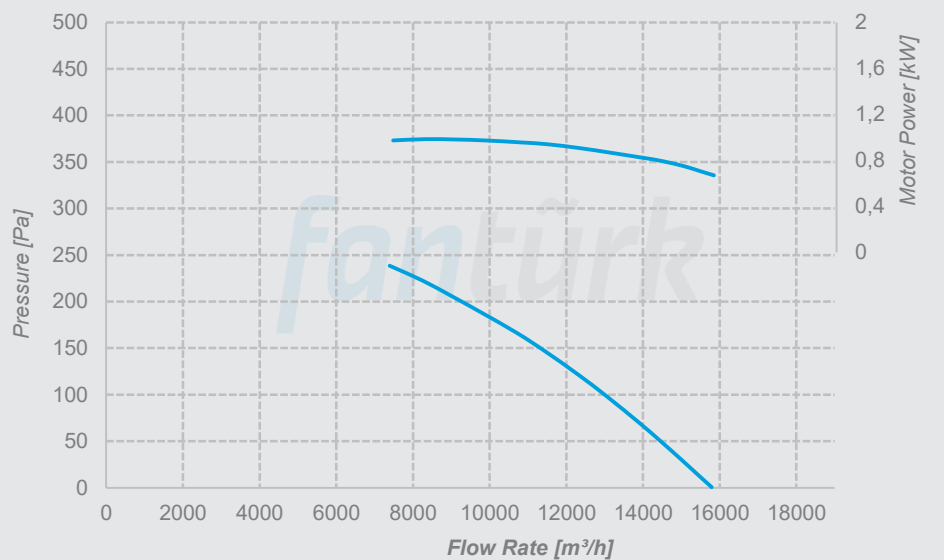

Performance Curves

D-FWA 800

Nos. of Blades 5
 Hub Size 5
 Pitch Angle 30°
 Nos. of Poles 4
 Material Aluminum

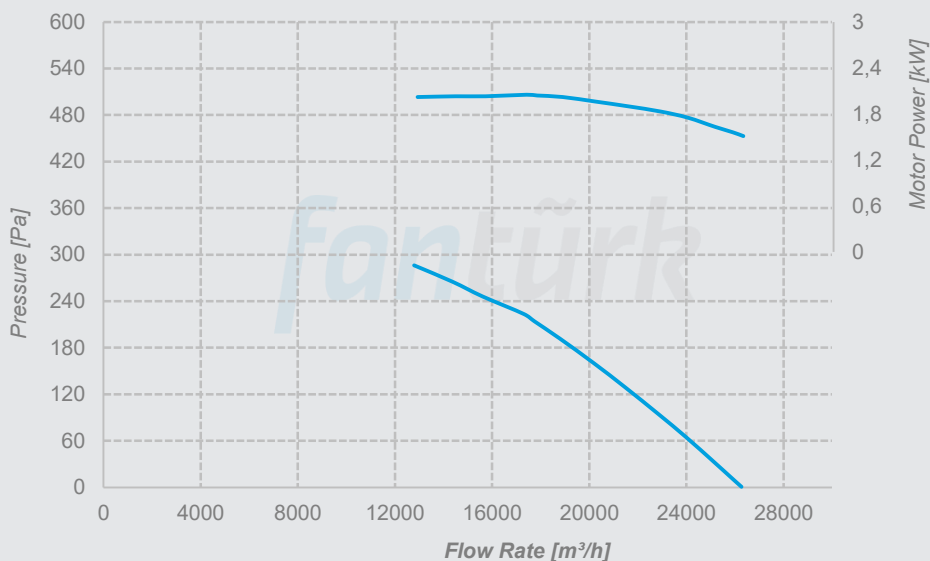

D-FWA 900

Nos. of Blades 5
 Hub Size 5
 Pitch Angle 35°
 Nos. of Poles 4
 Material Aluminum

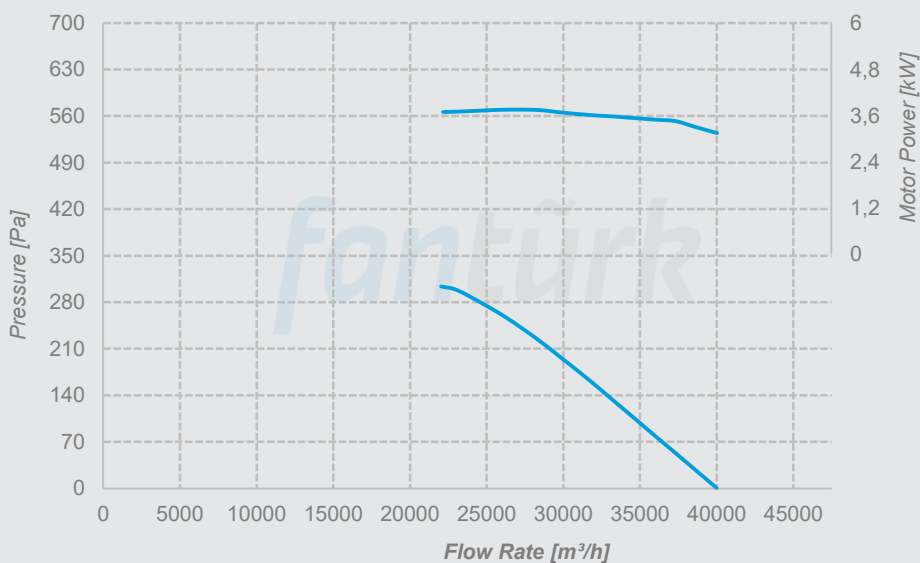

D-FWA 1000

Nos. of Blades 5
 Hub Size 5
 Pitch Angle 37,5°
 Nos. of Poles 4
 Material Aluminum

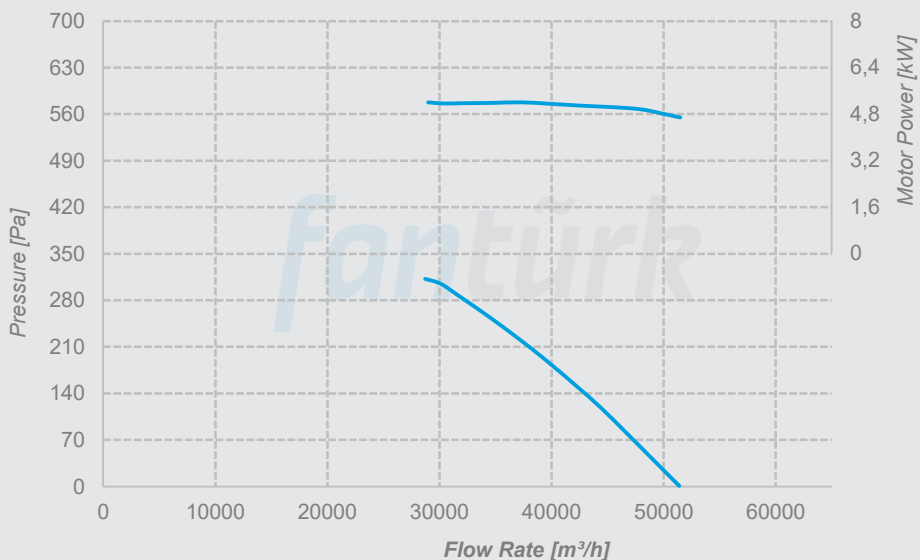

*Minarelicavus OSB District 202. Street No: 19 Nilüfer/Bursa Turkey
T: 90(224)482 50 95 E: info@fanturk.com.tr*

fanturk.com.tr